

Mouldpro Hot-Runner Temperature Controller

USER'S MANUAL

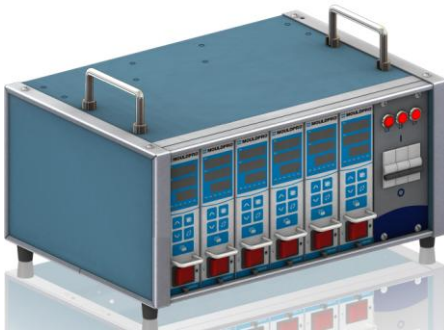



To avoid wrong operation, which may result in human injured or machine damage, please read this instruction carefully before use the instrument.

CONTENT

Chapter 1 TEMPERATURE CONTROL MODULE

1-1	<u>Features</u>	2
1-2	<u>Specification</u>	2
1-3	<u>Faceplate</u>	3
1-4	<u>Operation description</u>	5

Chapter 2 CABINET&ACCESSORIES

2-1	<u>Dimension</u>	11
2-2	<u>Specification</u>	12
2-3	<u>Connection description</u>	12
2-4	<u>Type of power wiring</u>	13
2-5	<u>Connector wiring</u>	15

Chapter 3 Trouble shooting

3-7	<u>Trouble shooting</u>	17
-----	-------------------------	----

Chapter 1 TEMPERATURE CONTROL MODULE

1-1 Feature

- Dual SV temperature control.
- Tri lines LED display.
- Auto /Manual function.
- PID auto temperature control.
- Selectable two thermocouple types.(J or K)
- Selectable two temperature scales.(°C or °F)
- Selectable six alarm modes.
- Selectable two trigger output modes.(Zero cross or phase angle)
- Fuse break indicator.
- Electric current, output percentage, frequency for power display function.
- Heater breaks, shorts out, wears out to detect and examine the function.
- Thermocouple break and inverse detect.
- Thermocouple range K TYPE 0~700°C(0~1200°F)/J TYPE:0~500°C(0~900°F).
- RS485 communication: ASCII and RTU molding.

1-2 Specification

- Power input : 220Vac±20%
- Power frequency : 50/60Hz
- Power consumption : 7W
- Input impedance : 3MΩ
- Output wattage : 3600W(Max)、15A/240Vac(Every module)
- Storage temperature : -20~70°C
- Working temperature : 0~50°C
- Work Humidity : 10~80%RH (Non-condensing)
- Control accuracy : ±0.25%
- Measurement accuracy : ±0.25%

1-3 Faceplate

1-3-1 Faceplate description

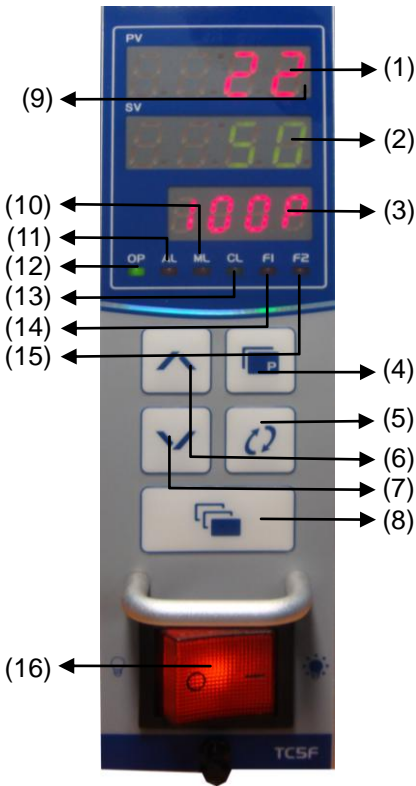

(1) PV :

- 1.Normal mode : Present value
- 2.Parameter mode : Parameter name

(2) SV :

- 1.Normal mode : Setting value
- 2.Parameter mode : Parameter name

3.Manual output or parameter: Manual output%

(3) Aux. display : output percentage, electric current, frequency display.

(4) PAGE key : Parameter level and parameter select key.

(5) Set key : Set enable and digital shift key.

(6) Increment key : Setting number increase.

(7) Decrement key : Setting number decrease.

(8) Aux. display PAGE key : Parameter select key

(9) PID tuning indicator : In PID tuning, progress indicator flashes.

(10) Manual output : Light up when Manual output

(11) Alarm indicator : Light up when alarm happen.

(12) output indicator : Light up when instrument output

(13) Cool indicator: While cooling the indicator lamp is on

(14) Fuse 1 indicator : Light up when fuse 1 break

(15) Fuse 2 indicator : Light up when fuse 2 break

(16) Power switch

1-3-2 Faceplate appearance and dimension

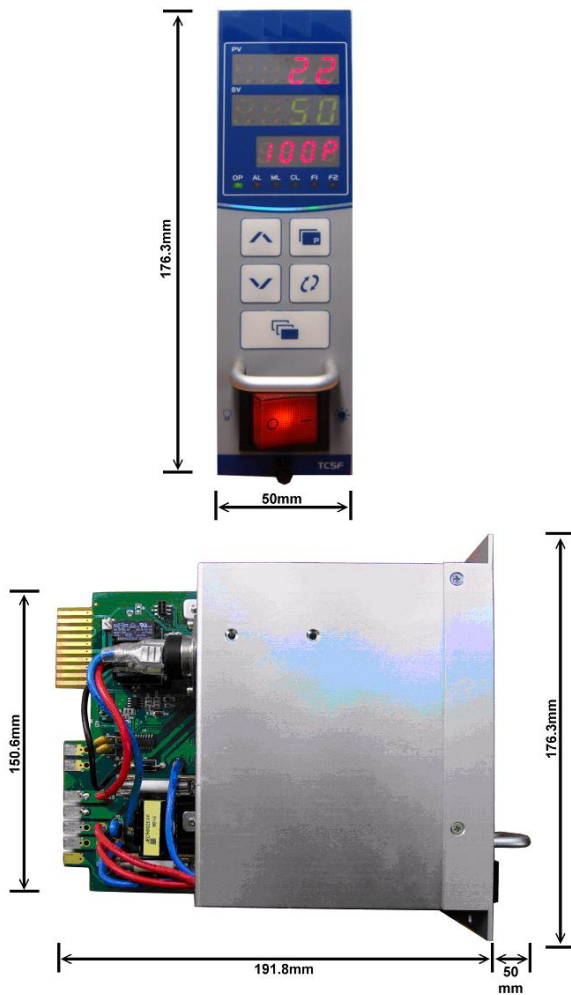

Deviation:±5mm

1-4 Operating description

1-4-1 Parameter flow chart

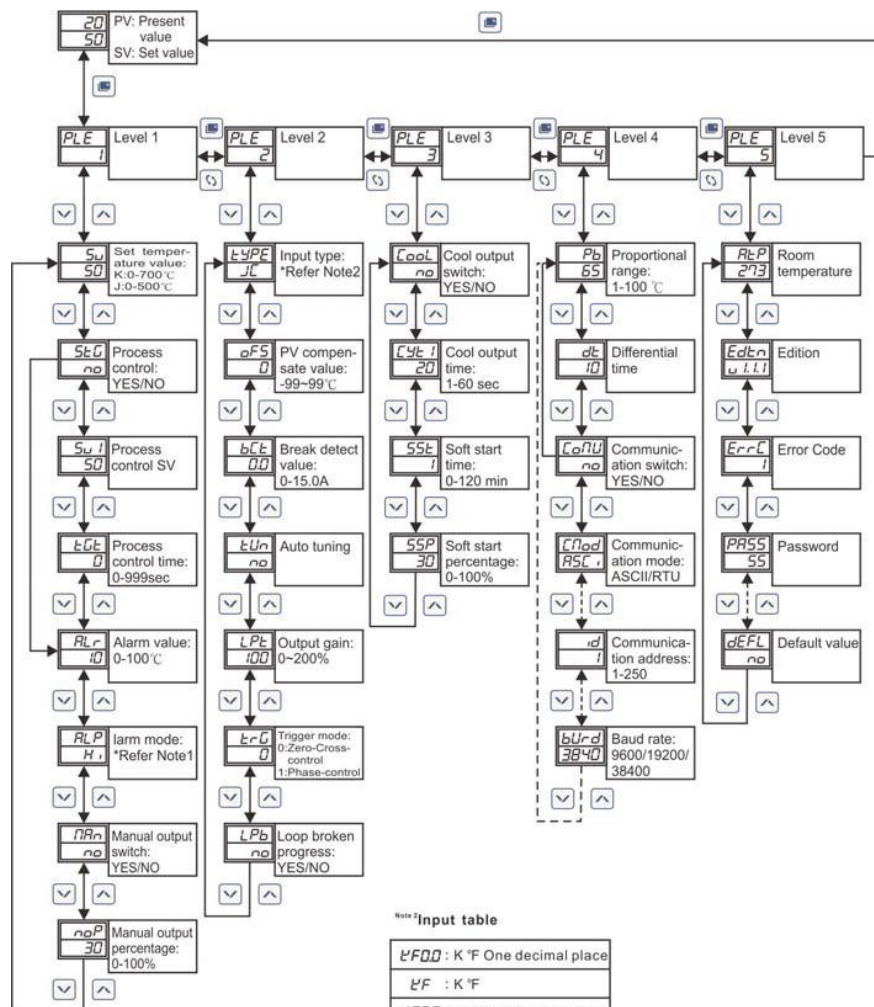

Note 2: Input table

YFQD	: K °F One decimal place
YF	: K °F
JFQD	: J °F One decimal place
JF	: J °F
YCDQ	: K °C One decimal place
YC	: K °C
JCDQ	: J °C One decimal place
JC	: J °C

Note 1: Alarm mode table

0:	No alarm
1:	Lo limit
2:	Hi limit
3:	Hi & Lo limit
4:	Lo limit alarm with stand-by
5:	Hi & Lo limit alarm with stand-by

1-4-2 Soft start (Heater dehumidify) function

To avoid the humidity burning the heater out, the soft start function could output a lower current to dehumidify the heater when the power turned on.

Soft start condition:

The soft start percentage (SSP) and time (SST). After power turned on, if $SV > PV$; $PV < 120^{\circ}\text{C}$, manual and PID tuning function are disabled, the soft start will be executed. Set SST to zero to stop soft start function.

Soft start action state :

Before SST time countdown completes, soft start outputs in 1%/sec accumulative mode until it gets SSP setting value. The accumulative mode will stop and wait SST time to complete countdown.

Soft start stop on halfway :

Press F for 2 sec to close soft start.

1-4-3 Control mode

Auto mode: The instrument performs PID auto temperature control

Manual mode: Manually adjust output percentage (UNIT displays "P") via NOP to hold the temperature.

Manual/Auto mode switch : Press display interchange for 2 sec.

1-4-4 Communication

Communication mode : Modbus ASCII / RTU

Baud rate : 9600/19200/(value of production38400)

ID : 1-250(value of production: 1)

According to the procedure of HMI

1-4-5 Process control :

Start conditions : STG is ON

Action mode : Before TGT time completes countdown. SV1 is the main display.

1. $PV < SV1 < SV$

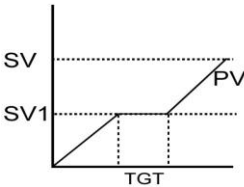

2. $SV1 < PV < SV$

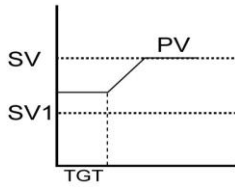

3. $SV1 < SV < PV$

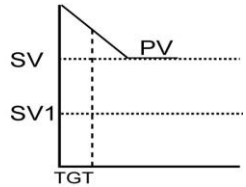

4. $PV < SV < SV1$

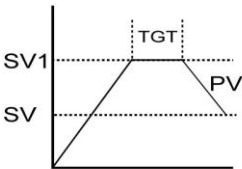

5. $SV < PV < SV1$

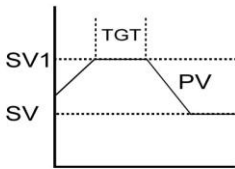

6. $SV < SV1 < PV$

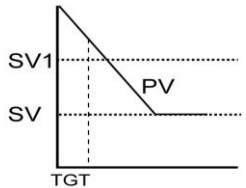

1-4-6 Over current protect

Control :

Regular : Actual current < 15 A

Malfunction: When actual current is >15A, the output will stop and O1ST display on the first set of monitor. After 1 minute, output resumes and detects the current. If it's 15A and it occurs more than 3 times, the output stops and the alarm starts with O1ST display. (PS: If the heater shorts out, the 20A fuse breaks)

TRIAC Malfunction : When start action delays within 30 sec, the module will force output ratio to 0%.

Regular : Actual current= 0 A.

Malfunction : When actual current is > 0 A, control will stop and alarm start, O1ST message will appear on first set of LED until the model starts power again.

1-4-7 Cooling control

Start term : COOL= ON

Action mode : The cycle time is CYT1. The output is P control way.

1-4-8 Alarm code ERRC

- 1 : Thermocouple break
- 2 : Thermocouple inverse
- 4 : Heat output short
- 8 : Heat output break

1-4-9 Error message

- (1) *----* : Thermocouple break
- (2) *, iBr* : Heater break
- (3) *, iLo* : PV lower than SV
- (4) *o iSt* : Heat output short

1-4-9 PID auto tuning function

To get the optimal PID value in some system, it is possible to execute "PID auto tuning" function at first use or heater system change

After finishing auto tuning, the optimal PID will be saved into the instrument and memory and will use the latest PID value for optimal temperature control.

PID auto tuning function:

(1)PV must be lower than 120°C or 180°F。

(2)SV must be higher than PV for 80°C or 100°F

(3)Set parameter TUN into YES。

PS : During PID auto tuning execution, the decimal point of PV will flash. After the instrument gets the optimal PID, the decimal point turns off and the instrument returns to auto temperature control.

Chapter 2 CABINET

2-1 Dimension

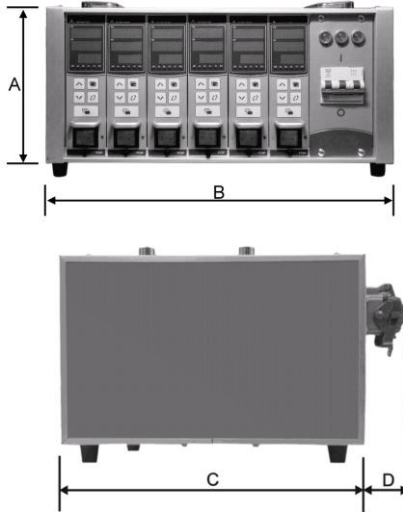

Unit : mm

Cabinet	A	B	C	D
1 Zone	188	96	248	30
2 Zones	215	223	299	45
4 Zones		323		
6 Zones		424		
8 Zones		524		
12 Zones		726		

2-2 Specification

Type	HRC001	HRC002	HRC004	HRC006	HRC008	HRC012
Zone	1	2	4	6	8	12

Item						
Power Switch (A)	--	32	50	50	63	63
Output connector	4pin+E (ground)	16pins x1	16pins x1	24pins x1	16pins x2	24pins x2
Power Cable	2.0mm ² x3C x3M	5.5mm ² x5C x3M	5.5mm ² x5C x3M	5.5mm ² x5C x3M	8.0mm ² x5C x3M	8.0mm ² x5C x3M
Weight (kg) (non-module)	1.75	7.25	9	11.25	12.5	16

2-3 Connection Description

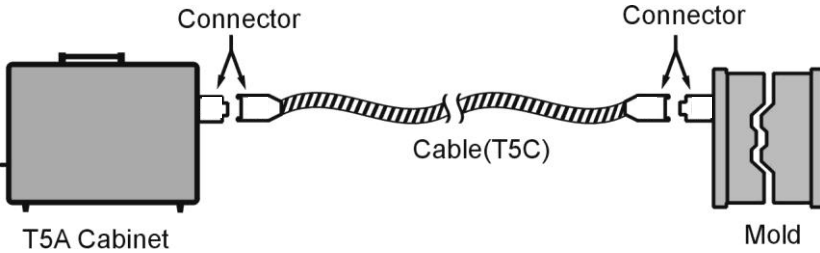

Connector type

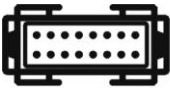

Dual hook



Dual button

*

2-4 Type of power wiring

A Power Disposition

Type: 3-Phase, 4-Wire, "Y" or "Δ"

Power Voltage: 200 - 242 Vac

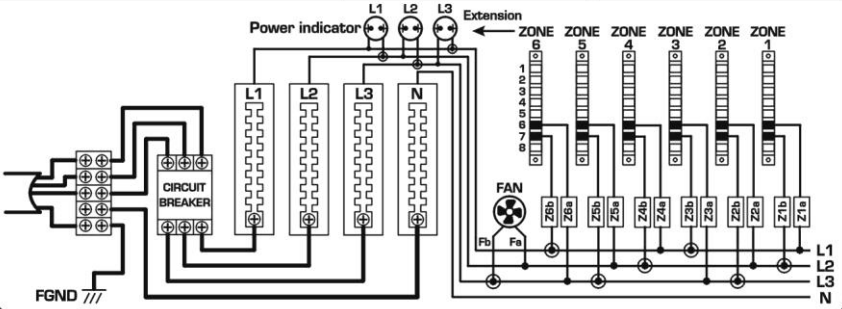
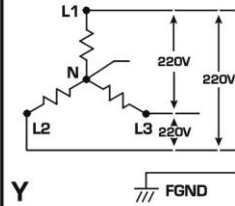
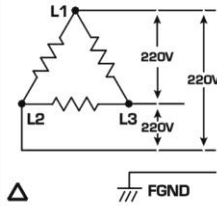

B Power Disposition

Type: 3-Phase, 5-Wire, "Y"

Power Voltage: 380 - 415 Vac

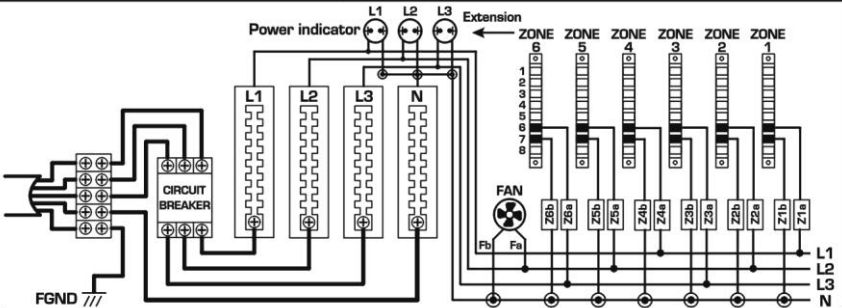
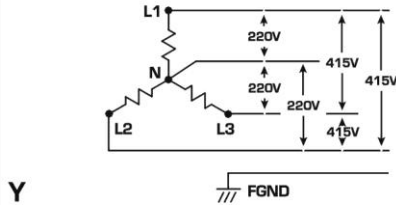

The following power wiring only for HRC001.

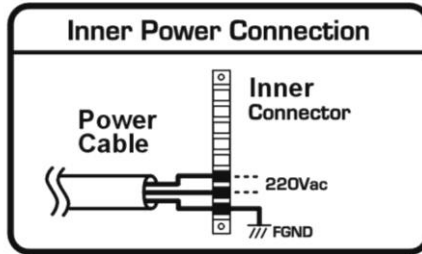

Caution

1. Before operating, check connection ("y" or "Δ") and its voltage.
2. All instruments must be used in accordance with the specification to prevent fire or damage to instrument and equipment.
3. Make sure the ac power input is switched off before maintenance.

Note: power type A and B differ with regard to "⊙" connections.

⚠ *The FGND must be connected with earth ground.*

2-4-4 Communication port

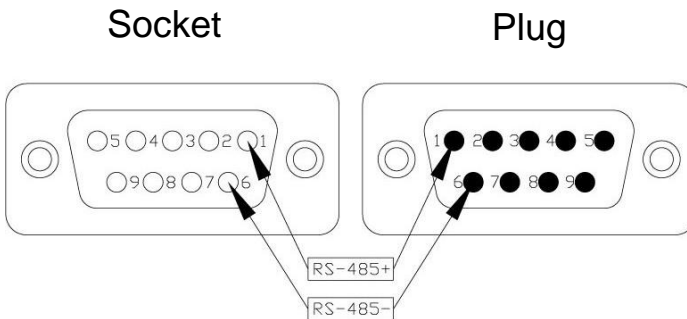

2-5 Connector wiring

Single cabinet connector wiring

ZONE	CONN	CONNECTOR ASSIGNMENT
1	4*1	
A4-1		

Multi-cabinet connector wiring are divided into A, B, C and D type as below:

A type wiring (STANDARD)

ZONE	CONN	CONNECTOR ASSIGNMENT
2	16*1	
A16-2		
4	16*1	
A16-4		
6	24*1	
A24-6		
8	16*2	
A16-8		
12	24*2	
A24-12		

B type wiring (Optional)

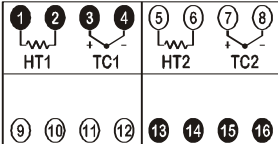
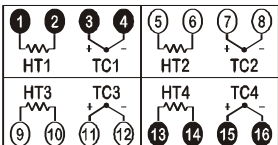
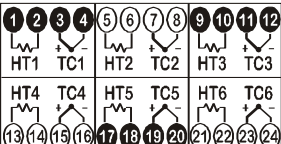
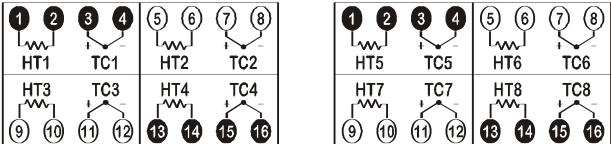
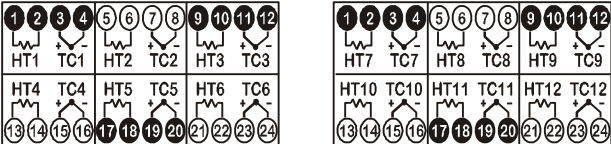
ZONE	CONN	CONNECTOR ASSIGNMENT
2	16*1	
B16-2		
4	16*1	
B16-4		
6	24*1	
B24-6		
8	16*2	
B16-8		
12	24*2	
B24-12		

C type wiring (Optional)

ZONE	CONN	CONNECTOR ASSIGNMENT
8	16*2	
C16-8		
12	24*2	
C24-12		

D type wiring (Optional)

ZONE	CONN	CONNECTOR ASSIGNMENT
2	16*1	
D16-2		
4	16*1	
D16-4		
6	24*1	
D24-6		
8	16*2	
D16-8		
12	24*2	
D24-12		

3-7 Trouble shooting

Malfunction status	Check item
1. No action after power on.	<ul style="list-style-type: none"> ● Module is installed properly? ● Power wiring is correct? ● Main power switch is malfunction? ● Module is malfunction?
2. F1 or F2 fuse break indicator bright.	<ul style="list-style-type: none"> ● Change the fuse accord with the brightly indicator.
3. Display " - - - ".	<ul style="list-style-type: none"> ● Module is installed properly? ● Thermocouple is break? ● Extension cable is loose or breaks? ● Module is malfunction?
4. Display " 000 ".	<ul style="list-style-type: none"> ● Thermocouple is reverse? ● Module is malfunction?
5. No display PV normally or PV unstable.	<ul style="list-style-type: none"> ● Refer to item 3. ● Power leakage? ● The ground is properly?
6. In the normal operation, the temperature cannot rise up.	<ul style="list-style-type: none"> ● Module is installed properly? ● Extension cable is loose or breaks? ● Heater is malfunction? ● Module (TRIAC) is malfunction?
7. Temperature control is unstable.	<ul style="list-style-type: none"> ● Refer 1-4-10, execute PID self – tuning.